

DATA SHEET



GaAs INTEGRATED CIRCUIT μ PG2250T5N

1.8 - 3.5 V, POWER AMPLIFIER FOR Bluetooth™ Class 1

DESCRIPTION

The μ PG2250T5N is a GaAs MMIC power amplifier developed for Bluetooth Class 1.

This device realizes high efficiency, high gain and high output power.

This device is housed in a 6-pin plastic TSON (Thin Small Out-line Non-leaded) package, and is suitable for high-density surface mounting.

FEATURES

- Operating frequency : $f_{opt} = 2\ 400$ to $2\ 500$ MHz (2 450 MHz TYP.)
- Supply voltage : $V_{DD1, 2, 3} = 1.5$ to 3.5 V (1.8 V TYP.)
- Control voltage : $V_{cont} = 1.5$ to 2.1 V (1.8 V TYP.)
- Circuit current : $I_{DD} = 100$ mA TYP. @ $V_{DD1, 2, 3} = 1.8$ V, $V_{cont} = 1.8$ V, $P_{out} = +19$ dBm
- <R> : $I_{DD} = 170$ mA TYP. @ $V_{DD1, 2, 3} = 3.0$ V, $V_{cont} = 1.8$ V, $P_{out} = +24$ dBm
- Output power : $P_{out} = +20.0$ dBm TYP. @ $V_{DD1, 2, 3} = 1.8$ V, $V_{cont} = 1.8$ V, $P_{in} = -5$ dBm
- <R> : $P_{out} = +25.0$ dBm TYP. @ $V_{DD1, 2, 3} = 3.0$ V, $V_{cont} = 1.8$ V, $P_{in} = -5$ dBm
- Gain control range : GCR = 60 dB TYP. @ $V_{DD1, 2, 3} = 1.8$ V, $V_{cont} = 0$ to 1.8 V, $P_{in} = -5$ dBm
- High efficiency : PAE = 55% TYP. @ $V_{DD1, 2, 3} = 1.8$ V, $V_{cont} = 1.8$ V, $P_{in} = -5$ dBm
- High-density surface mounting : 6-pin plastic TSON package ($1.5 \times 1.5 \times 0.37$ mm)

APPLICATION

- Power Amplifier for Bluetooth Class 1
- ZigBee Range Extender
- General 2.4GHz ISM Band PA Applications

ORDERING INFORMATION

Part Number	Order Number	Package	Marking	Supplying Form
μ PG2250T5N-E2	μ PG2250T5N-E2-A	6-pin plastic TSON (Pb-Free)	G5C	<ul style="list-style-type: none">• Embossed tape 8 mm wide• Pin 1, 6 face the perforation side of the tape• Qty 3 kpcs/reel

Remark To order evaluation samples, contact your nearby sales office.

Part number for sample order: μ PG2250T5N-A

Caution GaAs FET devices are sensitive to electrostatic discharge.

The information in this document is subject to change without notice. Before using this document, please confirm that this is the latest version.

PIN CONNECTIONS AND INTERNAL BLOCK DIAGRAM

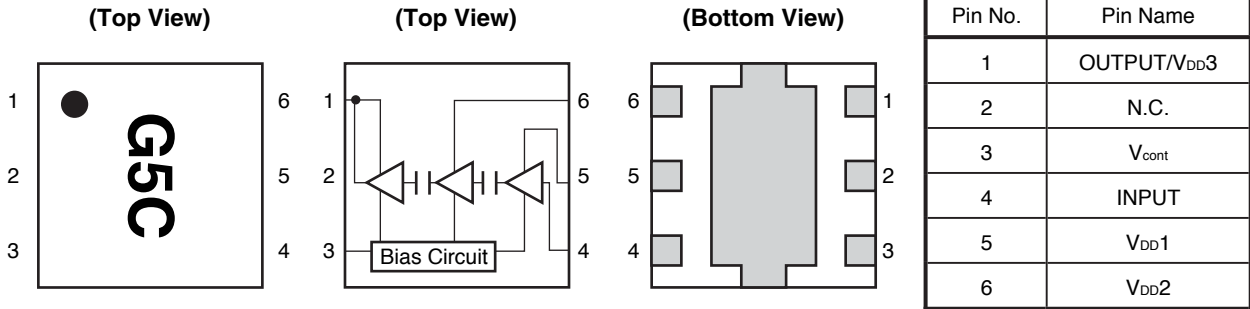

Remark Exposed pad : GND

ABSOLUTE MAXIMUM RATINGS (T_A = +25°C, unless otherwise specified)

Parameter	Symbol	Ratings	Unit
Supply Voltage	V _{DD1, 2, 3}	5.0	V
Control Voltage	V _{cont}	2.4	V
Circuit Current	I _{DD}	250	mA
Control Current	I _{cont}	5	mA
Input Power	P _{in}	+5	dBm
Power Dissipation	P _D	400 ^{Note}	mW
Operating Ambient Temperature	T _A	-40 to +85	°C
Storage Temperature	T _{stg}	-55 to +150	°C

Note Mounted on double-sided copper-clad 50 × 50 × 1.6 mm epoxy glass PWB, T_A = +85°C

RECOMMENDED OPERATING RANGE (T_A = +25°C, unless otherwise specified)

Parameter	Symbol	MIN.	TYP.	MAX.	Unit
Operating Frequency	f _{opt}	2 400	2 450	2 500	MHz
Supply Voltage	V _{DD1, 2, 3}	1.5	1.8	3.5	V
Control Voltage	V _{cont}	1.5	1.8	2.1	V

ELECTRICAL CHARACTERISTICS (T_A = +25°C, V_{DD1, 2, 3} = 1.8 V, V_{cont} = 1.8 V, f = 2 450 MHz, external input and output matching, unless otherwise specified)

<R>

<R>

Parameter	Symbol	Test Conditions	MIN.	TYP.	MAX.	Unit
Circuit Current	I _{DD}	P _{out} = +19 dBm	-	100	130	mA
		V _{DD1,2,3} = 3.0 V, P _{out} = +24 dBm	-	170	-	mA
Control Current	I _{cont}	P _{out} = +19 dBm	-	-	3	mA
Shut Down Current	I _{shut down}	V _{cont} = 0 V, RF None	-	-	5	μA
Output Power 1	P _{out1}	P _{in} = -5 dBm	+19	+20	-	dBm
		V _{DD1,2,3} = 3.0 V, P _{in} = -5 dBm	-	+25	-	dBm
Output Power 2	P _{out2}	V _{cont} = 0 V, P _{in} = -5 dBm	-	-40	-	dBm
Gain Control Range	GCR	V _{cont} = 0 to 1.8 V, P _{in} = -5 dBm	-	60	-	dB
Efficiency	PAE	P _{in} = -5 dBm	-	55	-	%
2nd Harmonics	2f ₀	P _{in} = -5 dBm	-	35	-	dBc

EVALUATION CIRCUIT

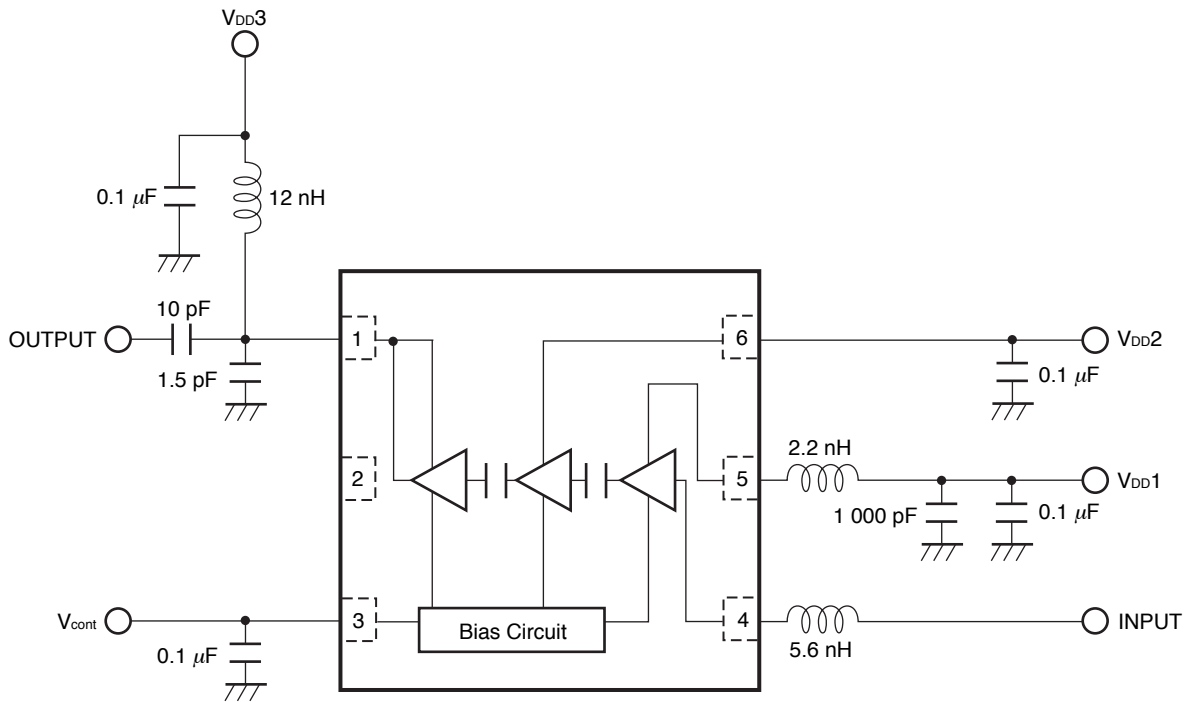

The application circuits and their parameters are for reference only and are not intended for use in actual design-ins.

<R> **TYPICAL CHARACTERISTICS (T_A = +25°C, f = 2 450 MHz, with external input and output matching circuits, unless otherwise specified)**

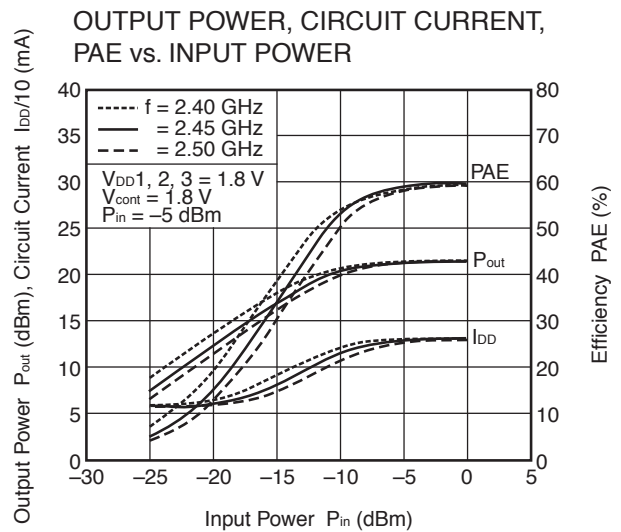
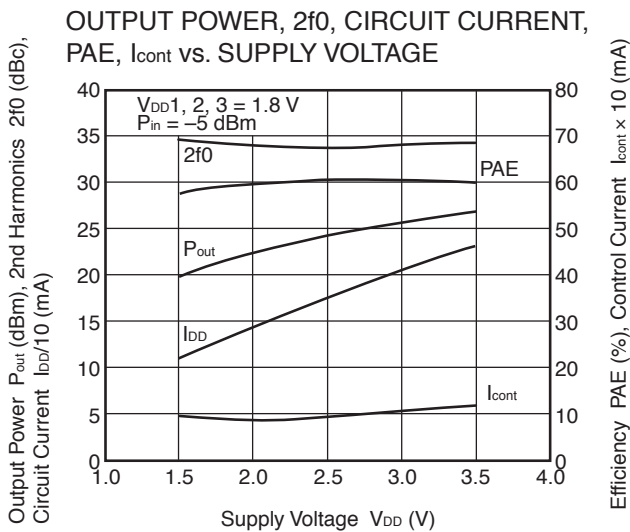
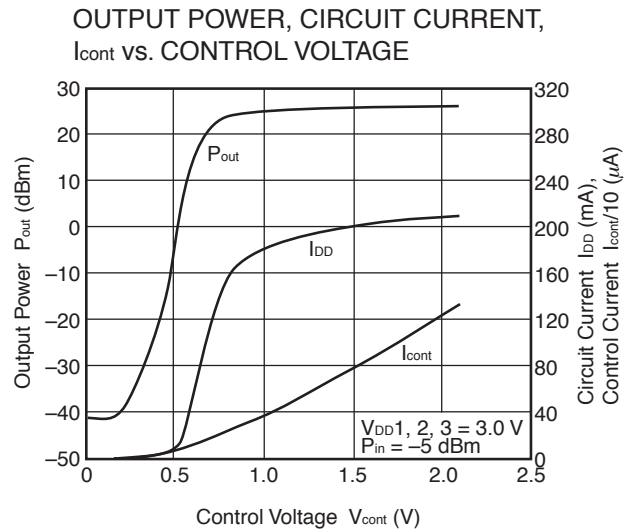
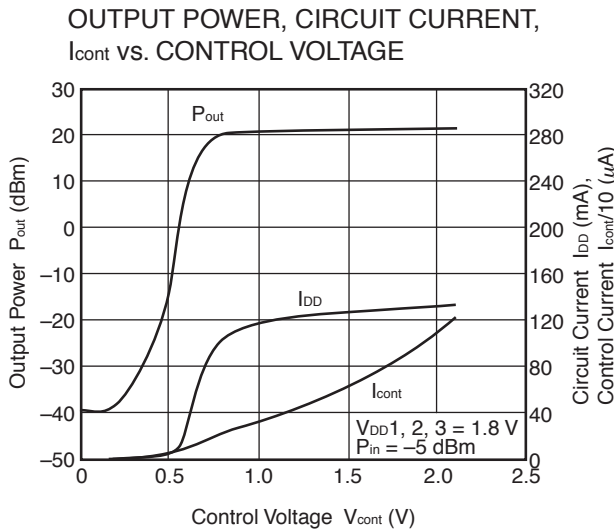
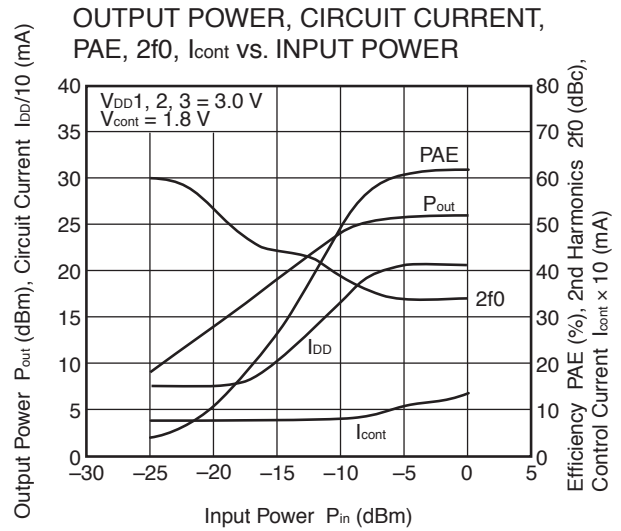
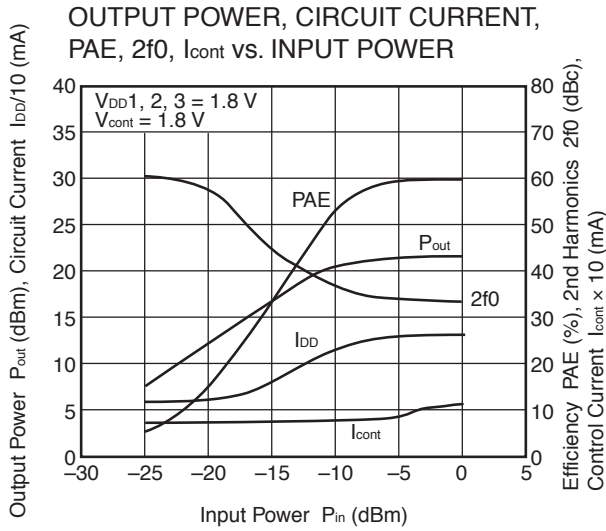

Remark The graphs indicate nominal characteristics.

<R> **S-PARAMETERS 1**

Condition : $f = 0.1$ to 6.1 GHz, $P_{in} = -30$ dBm, $V_{cont} = 1.8$ V, $V_{DD1} = V_{DD2} = V_{DD3} = 1.8$ V

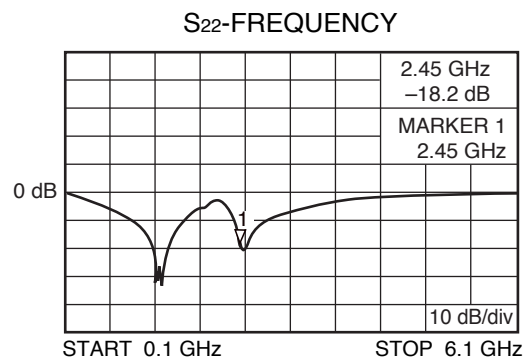
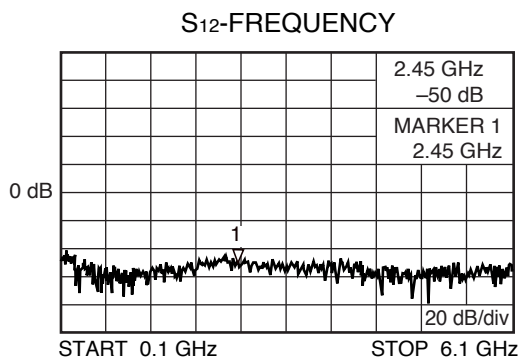
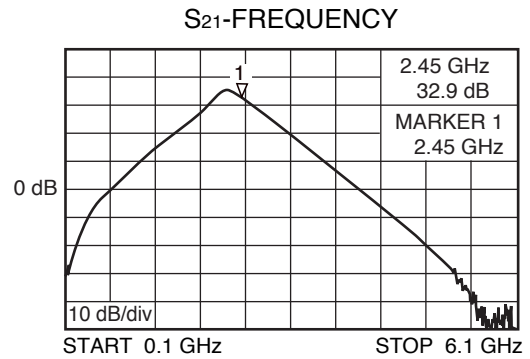
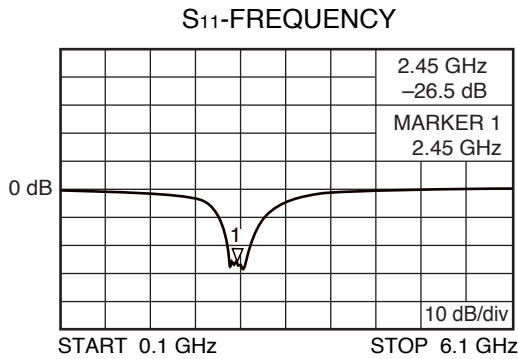

<R> **S-PARAMETERS 2**

Condition : $f = 0.1$ to 6.1 GHz, $P_{in} = -30$ dBm, $V_{cont} = 1.8$ V, $V_{DD1} = V_{DD2} = V_{DD3} = 3.0$ V

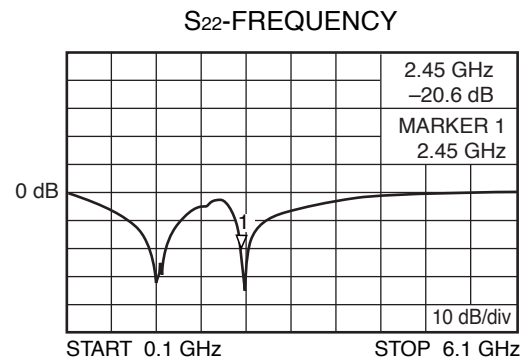
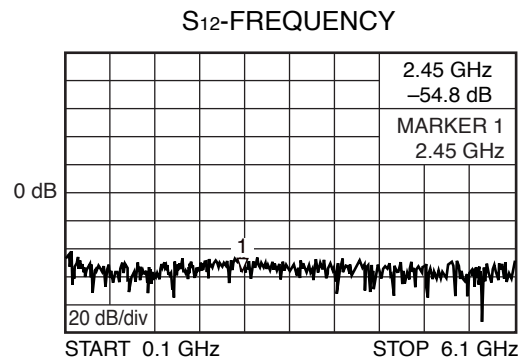
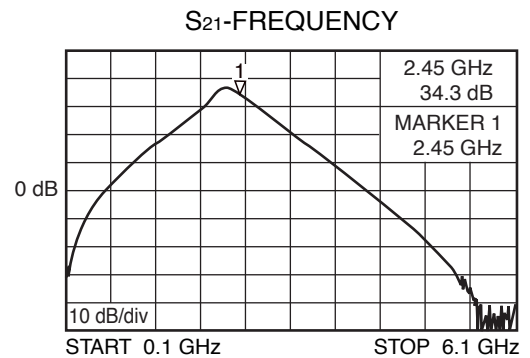
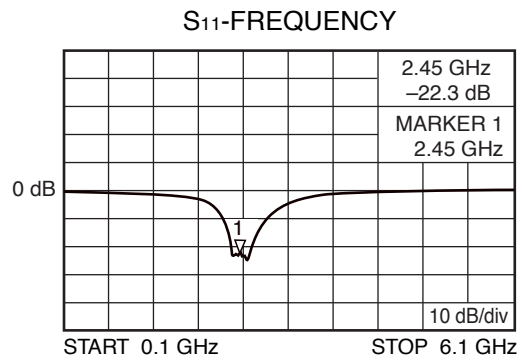

Remark The graphs indicate nominal characteristics.

MOUNTING PAD AND SOLDER MASK LAYOUT DIMENSIONS

6-PIN PLASTIC TSON (UNIT: mm)

MOUNTING PAD

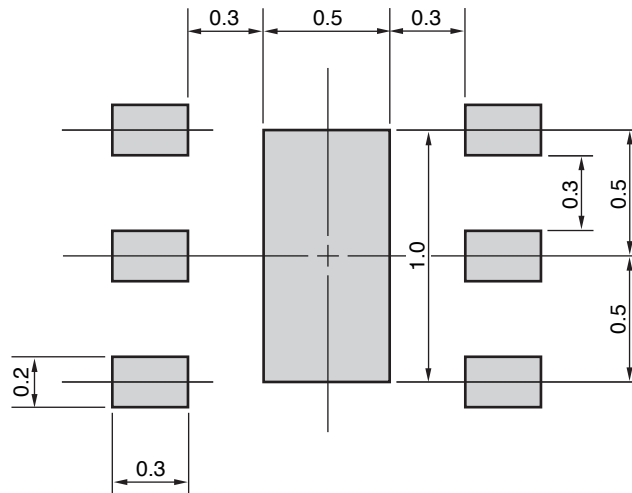

SOLDER MASK

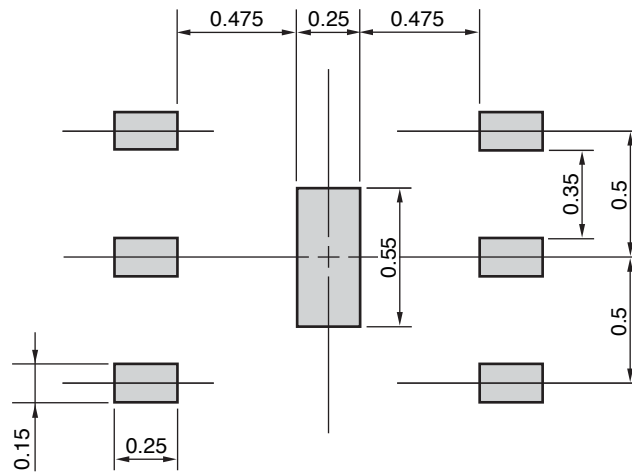

Solder thickness : 0.08 mm

Remark The mounting pad and solder mask layouts in this document are for reference only.

PACKAGE DIMENSIONS

6-PIN PLASTIC TSON (UNIT: mm)

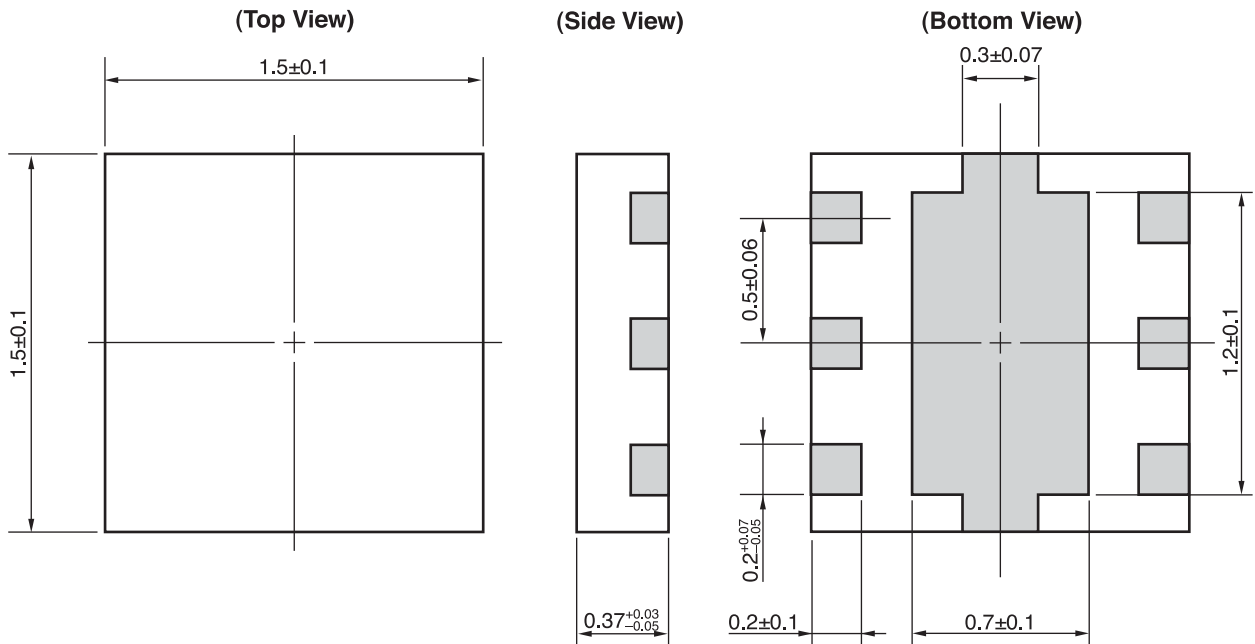

RECOMMENDED SOLDERING CONDITIONS

This product should be soldered and mounted under the following recommended conditions. For soldering methods and conditions other than those recommended below, contact your nearby sales office.

Soldering Method	Soldering Conditions	Condition Symbol
Infrared Reflow	Peak temperature (package surface temperature) : 260°C or below Time at peak temperature : 10 seconds or less Time at temperature of 220°C or higher : 60 seconds or less Preheating time at 120 to 180°C : 120±30 seconds Maximum number of reflow processes : 3 times Maximum chlorine content of rosin flux (% mass) : 0.2%(Wt.) or below	IR260
Wave Soldering	Peak temperature (molten solder temperature) : 260°C or below Time at peak temperature : 10 seconds or less Preheating temperature (package surface temperature) : 120°C or below Maximum number of flow processes : 1 time Maximum chlorine content of rosin flux (% mass) : 0.2%(Wt.) or below	WS260
Partial Heating	Peak temperature (terminal temperature) : 350°C or below Soldering time (per side of device) : 3 seconds or less Maximum chlorine content of rosin flux (% mass) : 0.2%(Wt.) or below	HS350

Caution Do not use different soldering methods together (except for partial heating).

Bluetooth is a trademark owned by Bluetooth SIG, Inc., U.S.A.

• **The information in this document is current as of June, 2007. The information is subject to change without notice. For actual design-in, refer to the latest publications of NEC Electronics data sheets or data books, etc., for the most up-to-date specifications of NEC Electronics products. Not all products and/or types are available in every country. Please check with an NEC Electronics sales representative for availability and additional information.**

- No part of this document may be copied or reproduced in any form or by any means without the prior written consent of NEC Electronics. NEC Electronics assumes no responsibility for any errors that may appear in this document.
- NEC Electronics does not assume any liability for infringement of patents, copyrights or other intellectual property rights of third parties by or arising from the use of NEC Electronics products listed in this document or any other liability arising from the use of such products. No license, express, implied or otherwise, is granted under any patents, copyrights or other intellectual property rights of NEC Electronics or others.
- Descriptions of circuits, software and other related information in this document are provided for illustrative purposes in semiconductor product operation and application examples. The incorporation of these circuits, software and information in the design of a customer's equipment shall be done under the full responsibility of the customer. NEC Electronics assumes no responsibility for any losses incurred by customers or third parties arising from the use of these circuits, software and information.
- While NEC Electronics endeavors to enhance the quality, reliability and safety of NEC Electronics products, customers agree and acknowledge that the possibility of defects thereof cannot be eliminated entirely. To minimize risks of damage to property or injury (including death) to persons arising from defects in NEC Electronics products, customers must incorporate sufficient safety measures in their design, such as redundancy, fire-containment and anti-failure features.
- NEC Electronics products are classified into the following three quality grades: "Standard", "Special" and "Specific".

The "Specific" quality grade applies only to NEC Electronics products developed based on a customer-designated "quality assurance program" for a specific application. The recommended applications of an NEC Electronics product depend on its quality grade, as indicated below. Customers must check the quality grade of each NEC Electronics product before using it in a particular application.

"Standard": Computers, office equipment, communications equipment, test and measurement equipment, audio and visual equipment, home electronic appliances, machine tools, personal electronic equipment and industrial robots.

"Special": Transportation equipment (automobiles, trains, ships, etc.), traffic control systems, anti-disaster systems, anti-crime systems, safety equipment and medical equipment (not specifically designed for life support).

"Specific": Aircraft, aerospace equipment, submersible repeaters, nuclear reactor control systems, life support systems and medical equipment for life support, etc.

The quality grade of NEC Electronics products is "Standard" unless otherwise expressly specified in NEC Electronics data sheets or data books, etc. If customers wish to use NEC Electronics products in applications not intended by NEC Electronics, they must contact an NEC Electronics sales representative in advance to determine NEC Electronics' willingness to support a given application.

(Note)

- (1) "NEC Electronics" as used in this statement means NEC Electronics Corporation and also includes its majority-owned subsidiaries.
- (2) "NEC Electronics products" means any product developed or manufactured by or for NEC Electronics (as defined above).

Caution GaAs Products	<p>This product uses gallium arsenide (GaAs). GaAs vapor and powder are hazardous to human health if inhaled or ingested, so please observe the following points.</p> <ul style="list-style-type: none">• Follow related laws and ordinances when disposing of the product. If there are no applicable laws and/or ordinances, dispose of the product as recommended below.<ol style="list-style-type: none">1. Commission a disposal company able to (with a license to) collect, transport and dispose of materials that contain arsenic and other such industrial waste materials.2. Exclude the product from general industrial waste and household garbage, and ensure that the product is controlled (as industrial waste subject to special control) up until final disposal.• Do not burn, destroy, cut, crush, or chemically dissolve the product.• Do not lick the product or in any way allow it to enter the mouth.
------------------------------	--

Subject: Compliance with EU Directives

CEL certifies, to its knowledge, that semiconductor and laser products detailed below are compliant with the requirements of European Union (EU) Directive 2002/95/EC Restriction on Use of Hazardous Substances in electrical and electronic equipment (RoHS) and the requirements of EU Directive 2003/11/EC Restriction on Penta and Octa BDE.

CEL Pb-free products have the same base part number with a suffix added. The suffix –A indicates that the device is Pb-free. The –AZ suffix is used to designate devices containing Pb which are exempted from the requirement of RoHS directive (*). In all cases the devices have Pb-free terminals. All devices with these suffixes meet the requirements of the RoHS directive.

This status is based on CEL’s understanding of the EU Directives and knowledge of the materials that go into its products as of the date of disclosure of this information.

Restricted Substance per RoHS	Concentration Limit per RoHS (values are not yet fixed)	Concentration contained in CEL devices	
		-A	-AZ
Lead (Pb)	< 1000 PPM	Not Detected	(*)
Mercury	< 1000 PPM	Not Detected	
Cadmium	< 100 PPM	Not Detected	
Hexavalent Chromium	< 1000 PPM	Not Detected	
PBB	< 1000 PPM	Not Detected	
PBDE	< 1000 PPM	Not Detected	

If you should have any additional questions regarding our devices and compliance to environmental standards, please do not hesitate to contact your local representative.

Important Information and Disclaimer: Information provided by CEL on its website or in other communications concerning the substance content of its products represents knowledge and belief as of the date that it is provided. CEL bases its knowledge and belief on information provided by third parties and makes no representation or warranty as to the accuracy of such information. Efforts are underway to better integrate information from third parties. CEL has taken and continues to take reasonable steps to provide representative and accurate information but may not have conducted destructive testing or chemical analysis on incoming materials and chemicals. CEL and CEL suppliers consider certain information to be proprietary, and thus CAS numbers and other limited information may not be available for release.

In no event shall CEL’s liability arising out of such information exceed the total purchase price of the CEL part(s) at issue sold by CEL to customer on an annual basis.

See CEL Terms and Conditions for additional clarification of warranties and liability.